

SUMMIT

4-BURNER ELECTRIC COOKTOPS Models CR4B23T5B & CR4B23T6W



User's Guide and Installation Instructions

Please read this manual carefully before use and keep it in a safe place for future reference.

FELIX STORCH, INC.
An ISO 9001:2008 registered company
770 Garrison Avenue
Bronx, New York 10474
www.summitappliance.com

TABLE OF CONTENTS

Important Safeguards	2 – 7
<i>Safety Precautions</i>	2 – 3
<i>Electrical Safety</i>	3
<i>Child Safety</i>	4
<i>Safety during Use</i>	4 – 5
<i>Safety When Cleaning</i>	6
<i>Cooking Meat and Poultry Thoroughly</i>	6
<i>How to Avoid Damaging the Appliance</i>	6 – 7
<i>Disposal of Old Appliances</i>	7
Selecting Cookware	8 – 9
<i>Pots and Pans</i>	8
<i>Use Flat-Bottomed Cookware</i>	8
<i>Avoiding Scratches</i>	8
<i>For Best Results</i>	9
<i>Tips for Saving Energy</i>	9
Parts and Features	10 - 11
<i>Cooktop Layout</i>	10
<i>Touch Control Features</i>	11
Operating Instructions	12 - 15
<i>Before Using the Cooktop</i>	12
<i>Setting the Controls</i>	12 - 13
<i>Using the Dual Cooking Zone</i>	14
<i>Using Child Lock</i>	14
<i>Timer Function</i>	14 - 15
<i>Other Functions</i>	15
Care and Cleaning	15 - 16
<i>Cleaning the Cooktop</i>	15
<i>Burned-On Residue</i>	16
<i>Metal Marks and Scratches</i>	16
Installation Instructions	16 - 24
<i>Before You Begin</i>	17
<i>Unpacking the Cooktop</i>	17
<i>Technical Specifications</i>	17
<i>Preparing the Installation Location</i>	18
<i>Dimensions and Clearances</i>	19 - 20
<i>Electrical Connections</i>	20 - 22
<i>Cooktop Installation</i>	23 - 24
<i>Final Check</i>	24
Troubleshooting	25
Limited Warranty	27

IMPORTANT SAFEGUARDS

READ ALL INSTRUCTIONS BEFORE USE



WARNING: For your safety, the information in this manual must be followed to minimize the risk of fire, electric shock, or to prevent property damage, personal injury, or death.

SAFETY PRECAUTIONS

- Proper Installation: Be sure your appliance is properly installed and grounded by a qualified technician in accordance with the National Electrical Code ANSI/NFPA No. 70, latest edition in the United States, and all local code requirements. Install only per installation instructions.
- Do not attempt to repair or replace any part of your cooktop unless it is specifically recommended in this manual. All other service should be referred to a qualified technician.
- Remove all tape and packaging wrap before using the appliance. Dispose of the carton and plastic bags after unpacking the appliance. Never allow children to play with packaging material.
- The safety aspects of this appliance comply with accepted technical standards.
- Know how to disconnect the electrical power to the appliance at the circuit breaker or fuse box in case of an emergency. Mark the breaker or fuse for ease of identification and swift action if necessary.
- Do not repair or replace any part of the appliance. All servicing should be done only by a qualified technician to avoid the risk of personal injury and damage to the appliance.
- Never modify or alter the construction of an appliance, e.g., by removing panels, wire covers or any other permanent part of the product.
- Storage on appliance: Flammable materials should not be stored near or on the cooking surface. This includes paper, plastic and cloth items, such as cookbooks, plastic ware and towels, as well as flammable liquids. Do not store explosives, such as aerosol cans, on or near the appliance. Flammable materials may explode and result in fire or property damage.
- Do not leave children alone. Children should not be left alone or unattended in the area where an appliance is in use. They should never be allowed to sit or stand on any part of the appliance.
- Do not store or use gasoline or other flammable vapors and liquids in the vicinity of this or any other appliance.



CAUTION: Items of interest to children should not be stored in cabinets above a cooktop or on the backsplash of a cooktop—children climbing on the cooktop to reach items could be seriously injured.

 **WARNING:** Never use your appliance for warming or heating a room.

 **CAUTION:** **DO NOT touch Cooking Zones or areas near these surfaces.** Cooking Zones may be hot from residual heat even though they are dark in color. Areas near the Cooking Zones may become hot enough to cause burns. During and after use, do not touch or let clothing or other flammable materials touch these areas until they have had sufficient time to cool.

 **CAUTION:** **Never wear loose fitting or hanging garments while using this appliance.**

- Always turn off all controls when cooking is completed.
- Never allow children to sit or stand on any parts of the appliance as they could be injured or burned.
- **Wear proper apparel. Loose-fitting or hanging garments should never be worn while using the appliance.** Do not let clothing or other flammable materials contact hot surfaces.
- **Do not use water or flour on grease fires.** Smother the fire with a pan lid, or use baking soda, a dry chemical or foam-type extinguisher.
- **When heating fat or grease, watch it closely.** Fat or grease may catch fire if allowed to become too hot.
- **Use only dry pot holders.** Moist or damp pot holders on hot surfaces may result in burns from steam. Do not let the pot holders touch hot surface units. Do not use a towel or other bulky cloth instead of a pot holder.
- **Do not heat unopened food containers.** Buildup of pressure may cause the container to burst and result in injury.

ELECTRICAL SAFETY

 **WARNING**

- **If the surface is cracked, switch off the appliance to avoid the possibility of electric shock. Do not use your COOKTOP again until the glass surface has been changed.**
- **When using the COOKTOP, never use aluminum foil, products wrapped in aluminum foil, or deep-frozen food in aluminum cookware.**
- **If the supply cord is damaged, it must be replaced by the manufacturer, its service agent or similarly qualified persons in order to avoid a hazard.**
- The installation and connection of the new appliance must only be carried out by qualified personnel.
- Flush-mounted appliances may only be operated following installation in suitable cabinets and workplaces which conform to the relevant standards. This ensures sufficient protection against electric shock as required by certification agencies.
- If your appliance malfunctions or fractures, switch off all cooking zones, and contact the Service Center.

CHILD SAFETY



WARNING:

- **This appliance is not intended for use by young children or infirm persons unless they have been adequately supervised by a responsible person to ensure that they can use the appliance safely.**
- **Young children should be supervised to ensure that they do not play with the appliance.**
- **Accessible parts may become hot during use. Young children should be kept away.**

SAFETY DURING USE

- **This appliance may only be used for normal cooking and frying in the home.** It is not designed for commercial or industrial purposes.
- **Do not use the cooktop to heat the room.**
- **Take care when plugging in electric appliances near the cooktop.** Cords must not come into contact with the hot surface. This could cause damage to the cooktop and cable insulation.
- **Overheated fats and oils catch fire quickly.** You should supervise cooking when preparing foods in fat or oil.
- **After use, switch off the burner element by its control.**
- **Always keep the control panels clean and dry.** Do not let liquids or grease remain on the cooktop controls area. Spilled or burnt-on foods can activate or deactivate the appliance. Clean the controls area thoroughly to resume normal operation of the appliance.
- **Never place combustible items on the cooktop.**
- **Never keep any combustible items or aerosol cans in a drawer located under the cooktop.**
- **Avoid placing metal cooking utensils like spoons and spatulas on the cooking surface areas.** Metal objects can become hot and cause burns.
- **Know which touch keypad controls each surface of the cooking zones.**
- **Clean the appliance regularly to keep all parts free of grease that could catch fire.** Exhaust fan ventilation hoods and grease filters should be kept clean. Do not allow grease to accumulate on hood or filter. Greasy deposits in the fan could catch fire. Refer to hood manufacturer's instructions for cleaning.
- **Use Proper Pan Sizes.** This appliance is equipped with surface units of different sizes. Select utensils having flat bottoms large enough to cover the surface unit heating element. The use of undersized utensils will expose a portion of the heating element to direct contact and may result in ignition of clothing. Proper relationship of utensil to burner will also improve efficiency.
- **If pan is smaller than element,** a portion of the element will be exposed to direct contact and could ignite clothing or potholder.

- **Do not place any object on or near the control keypad area in order to prevent accidental activation of the cooktop controls.**
- **Utensil Handles Should Be Turned Inward and Not Extend Over Adjacent Surface Units.** To reduce the risk of burns, ignition of flammable materials, and spillage due to unintentional contact with the utensil, the handle of a utensil should be positioned so that it is turned inward, and does not extend over adjacent surface units.
- **Never leave prepared food on the Cooking Zones.** Boil-overs cause smoking and greasy spillovers that may ignite, or a pan that has boiled dry may melt or become damaged.
- **Protective liners: Do not use aluminum foil to line any part of the cooktop.** Only use aluminum foil as recommended after the cooking process, if used as a cover to be placed over the food. Any other use of aluminum foil may result in the risk of electric shock, fire or short circuit.
- **Glazed cooking utensils: Only certain types of glass, glass/ceramic, ceramic, earthenware, or other glazed utensils are suitable for rangetop service without breaking due to the sudden change in temperature.**
- **Ventilating hood: The ventilating hood above your cooking surface should be cleaned frequently so the grease from cooking vapors does not accumulate on the hood or filter.**
- **Do not clean or operate a broken cooktop.** If cooktop should break, cleaning solutions and spillovers may penetrate the broken cooktop and create a risk of electric shock. Contact a qualified technician immediately.
- **Clean cooktop with caution.** Do not use sponges or cloth to wipe spills on a hot cooking area. Use a proper metal scraper.
- **Do not place hot cookware on cold cooktop glass.** This could cause glass to break.
- **Do not slide pans across the cooktop surface.** They may scratch the cooktop surface.
- **Do not let pans boil dry.** This may cause permanent damage in the form of breakage, fusion, or marking that can affect the ceramic glass cooktop. (This type of damage is not covered by your warranty.)
- **Never leave surface units unattended at high heat settings.** Boil-over causes smoking and greasy spillovers that may ignite.
- Smother fire or flame in a pan with a lid or cookie sheet. **NEVER** pick up or move a flaming pan.
- Do not use water on grease fires. Use baking soda or a dry chemical or foam-type extinguisher to smother fire or flame.
- **Always turn off all controls when cooking is completed.**
- **Be sure you know which control pads operate each surface unit.** Make sure you turned on the correct surface unit.
- **Use only dry potholders.** Moist or damp pot holders on hot surfaces may results in burns from steam. Do not let the pot holder touch hot heating elements. Do not use a towel or other bulky cloth.

SAFETY WHEN CLEANING

- **Always switch off the appliance before cleaning.**
- **For safety reasons, do not clean the appliance with a steam jet or high-pressure cleaner.**
- **Clean the cooktop in accordance with the maintenance and cleaning instructions in this manual.**
- **Steam cleaners are not to be used for cleaning of the cooktop.**
- **Do not use harsh abrasive cleaners or rough metal scrapers to clean the cooktop glass since they can scratch the surface, which may result in shattering of the glass.**
- **Clean Cooktop With Caution.** Do not use sponges or cloth to wipe spills on a hot cooking area. Use a proper metal scraper.

COOKING MEAT AND POULTRY THOROUGHLY

Cook meat and poultry thoroughly – meat to at least an INTERNAL temperature of 160°F and poultry to at least an INTERNAL temperature of 170°F. Cooking to these temperatures usually protects against food-borne illness.

HOW TO AVOID DAMAGING THE APPLIANCE

- Prior to using your cooktop for the first time, apply a recommended cooktop cleaning cream to the ceramic surface. Buff with a non-abrasive cloth or pad. This will make cleaning easier when surface is soiled from cooking. The special cooktop cleaning cream leaves a protective finish on the glass to help prevent scratches and abrasions.
- Do not use the cooktop as a work surface or storage space.
- Please be careful of the edges when moving pots and pans.
- Do not operate the cooking zones with empty pots or pans.
- Do not turn on a cooking zone with no pot or pan on the element.
- Ceramic glass is very tough and impervious to sharp temperature changes, but is not unbreakable. It can be damaged if hard or sharp objects fall on it.
- Be very cautious if using pots made of cast iron, or other pots with rough edges or burrs. Moving these can cause scratches on glass.
- If sugar or a mixture containing sugar falls onto a hot cooking zone and melts, remove immediately, while still hot. If left to cool down, it may damage the surface when removed.
- Do not slide metal or glass across the cooktop surface.
- Keep objects or materials that are liable to melt away from the ceramic glass surface, for example, plastic utensils, aluminum foil, or cooking wraps. If any materials or foodstuffs melt on the ceramic glass surface, these should be cleaned up immediately.

NOTE: There is a risk of burning yourself when the glass scraper is used on a hot cooking zone!

- Do not use cookware with any dirt build-up on the bottom.

- Do not use cookware with rough or uneven bottoms. This cookware can mark and scratch the cooktop surface.
- See elsewhere in this manual for proper cleaning and maintenance of the cooktop.
- **Do not use the glass cooktop surface as a cutting board.**
- **Never cook directly on the glass. Always use cookware.**



CAUTION

Burn Hazard: The Cooking Zones may appear cool when turned ON and after they have been turned OFF. Take note of the Residual Heat Indicator above each cooking zone key.

DISPOSAL OF OLD APPLIANCES

To protect the environment, it is important that worn-out appliances be disposed of in the proper manner.

- The appliance must not be disposed of with household rubbish.
- You can obtain information about collection dates or public refuse disposal sites from your local government office or environmental health facility.



CAUTION

Before disposing of old appliances please make them inoperable so they cannot be a source of danger. To do this, have a qualified person disconnect the appliance from the house circuitry.

READ AND FOLLOW THIS SAFETY INFORMATION CAREFULLY.

– SAVE THESE INSTRUCTIONS –

SELECTING COOKWARE

POTS AND PANS

The better the pot, the better the cooking results.

- You can recognize good pots and pans by their bases. The base should be as thick and flat as possible.

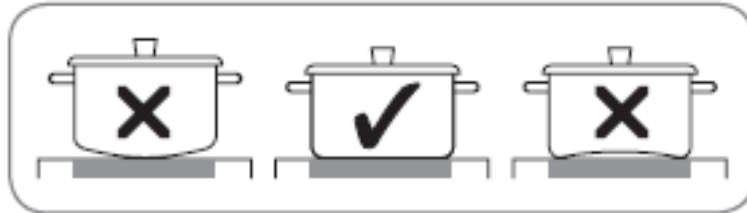

- Pots with aluminum or copper bases can cause metallic discoloring on the ceramic glass surface which is very difficult or impossible to remove.
- Be very careful when using cast iron pots or pots with damaged bases which are rough and/or have burrs on them. Scratches can occur if they are slid across the surface.
- When cold, pot bases are normally bowed slightly inwards (concave). They should never be bowed outwards (convex).
- If you wish to use a special type of pan (e.g., a pressure cooker, simmering pan, wok), please follow the manufacturer's instructions and do not use a very thin pan.

USE FLAT-BOTTOMED COOKWARE

Cookware must fully contact the surface of the cooking element. Use flat-bottomed pans sized to fit the cooking element and amount of food being prepared. Check for flatness by rotating a ruler across the bottom of the cookware.

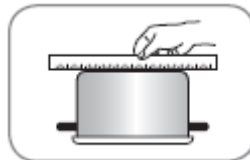

AVOIDING SCRATCHES

- It is recommended to always use heavier gauge stainless steel cookware on your ceramic cooktop surface. This will help reduce the possibility of developing scratches on the ceramic surface. Low-quality cookware can scratch the cooktop surface.
- Cookware should always be lifted over the ceramic cooktop surface to prevent scratching.
- Sliding any type of cookware over the ceramic cooktop can affect the overall appearance of the cooktop. Over time, sliding ANY type of cookware over the ceramic cooktop may alter the overall appearance of the cooktop. Eventually, the buildup of scratches can make cleaning the surface difficult and degrade the overall appearance of the cooktop.
- Scratches can also result from grains of sand (e.g., after washing vegetables) which are dragged with the pot across the cooking surface.

FOR BEST RESULTS

Always follow the recommendations for proper cookware type and size. In addition:

- Do not use dirty pans with grease buildup. Always use pans that are easy to clean after cooking, and make sure that the bottoms of the pans are clean and dry.
- When cooking with large amounts of liquid, use large pots so that nothing can boil over.
- Do not let pans boil dry. This may cause permanent damage in the form of breakage, fusion, or marring that can affect the ceramic cooktop. (This type of damage is not covered by your warranty.)
- Match the pan size and Cooking Zone to the amount of food being prepared.

TIPS FOR SAVING ENERGY

- Always position pots and pans before you switch on the Cooking Zone.
- Dirty cooking zones and cookware use more electricity.
- Whenever possible, always have the lid firmly placed on the pots and pans so that they are completely covered.

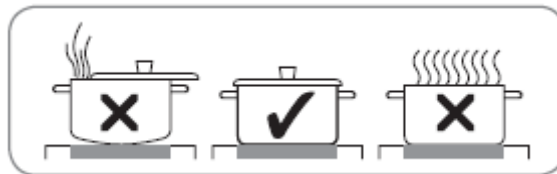

- Switch off the cooking zones before the end of the cooking time to use the residual heat for keeping food warm or for melting purpose.
- The base of the pot should have the same size as the cooking zone.

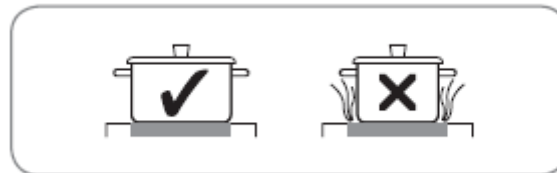

- Using a pressure cooker shortens the cooking times by up to 50%.

PARTS AND FEATURES

Throughout this manual, features and appearance may vary from your model.

COOKTOP LAYOUT



TOUCH CONTROL FEATURES

LOCATIONS OF SURFACE ELEMENTS AND CONTROLS

Refer to the diagram below to locate the control button for each of the surface burner elements on the cooktop.

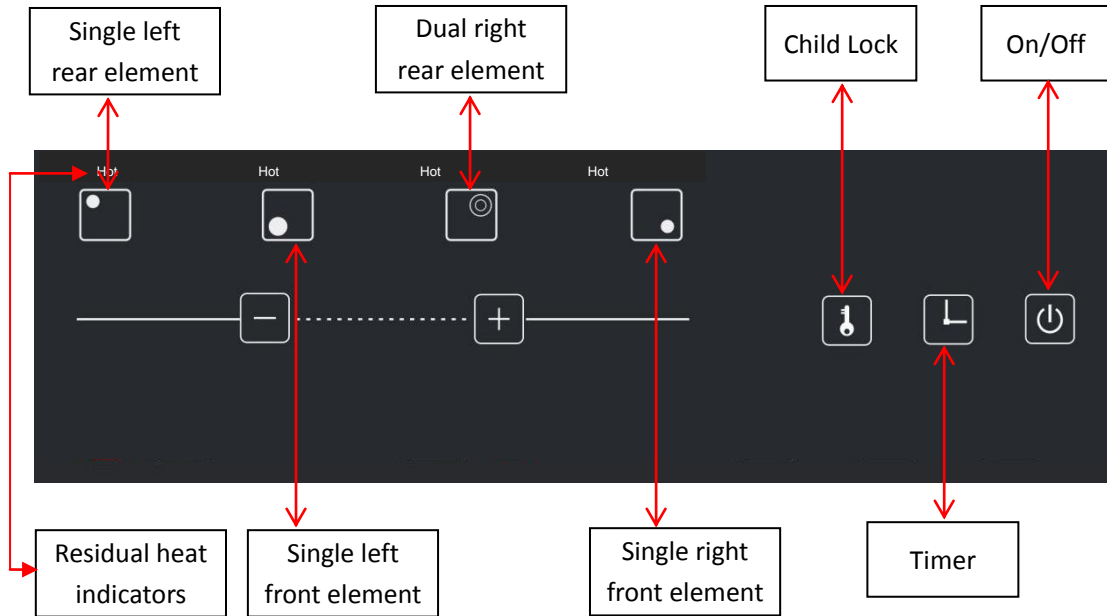

POWER ON/OFF: Touch the POWER ON/OFF button to turn the entire cooktop ON and OFF. When it is ON, the cooktop is in standby mode until a Cooking Zone is activated.

CHILD LOCK: With this key the controls can be locked as a safety precaution for children. Press once and all buttons are locked except the ON/OFF button. When you touch this key once more for 3 sec., Child Lock will be released. Or you can press ON/OFF to cancel this setting.

To set the element power level: Select the desired Cooking Zone



for the active Cooking Zone to adjust the power level from **0** to **9**.

RESIDUAL HEAT INDICATORS: Your cooktop has a residual heat indicator, marked **Hot**, over each Cooking Zone key. The indicator warns that this area has been used and is still giving off enough heat to cause burns. *Avoid touching the Cooking Zone when this indicator is lit.* Although the cooktop is OFF, the light will stay lit until the cooktop has cooled down.

OPERATING INSTRUCTIONS

BEFORE USING THE COOKTOP

Before using the cooktop for the first time, clean it thoroughly with an approved ceramic cooktop cleaner according to the *Care and Cleaning* instructions in this guide. This will help protect the ceramic surface and make future cleanups easier.



CAUTION

Never use scrub pads or abrasive or etching cleansers. They can cause permanent damage to the cooktop surface.

SETTING THE CONTROLS

To operate the touch control pads, touch the pad firmly with the flat part of your fingertip.

First operation

The first time that power is supplied to the cooktop, a beep will sound and all indicators and the LED display will flash once. The ON/OFF light starts to flash. The Cooking Zone display shows – indicating the appliance is connected to a power source. Press the ON/OFF pad once, The ON/OFF light remains on, indicating that the appliance is in selection mode. Press the corresponding Cooking Zone pad to start operation.

Activating the cooktop

To turn ON the cooktop, touch the POWER ON/OFF pad for approximately 2 seconds. The indicator above the pad will light.

To turn OFF the cooktop, touch the POWER ON/OFF pad. The indicator light above the pad will start to flash.

NOTE: After turning on the cooktop with the POWER ON/OFF pad, you must select one of the Cooking Zones within 60 seconds using the Cooking Zone pad. If no selection is made, the cooktop will turn off for safety.

Selecting the Cooking Zone and Power Level

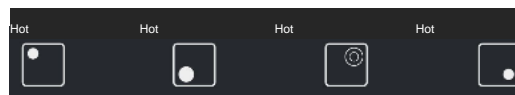

To select the desired Cooking Zone, touch the pad. The display for the selected Cooking Zone will show 5. Then press

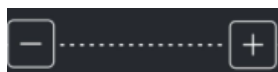

to adjust the power level from 0 to 9.

To readjust the power level:

Select a Cooking Zone, then select the desired power level. If a new power level is not selected after 5 seconds, the power level of the Cooking Zone will remain the same.

To turn OFF the Cooking Zone

- ① After the cooking is complete, touch the  pad to **0** to turn off the Cooking Zone. The corresponding Cooking Zone display will turn off. (*Remember that the burner is still hot while the Residual Heat Indicator is lit.*)
- ② If the POWER ON/OFF pad is selected, all Cooking Zones will shut off.

Functions and uses of power levels

Setting	Function	Used for
7-8	Heaving browning, deep fat frying	Browning meals, heating oil for deep fat frying, sautéing, maintaining a fast boil for large amounts of liquid
6-7	Roasting, frying	Frying meats, chops, pancakes, sausages, eggs
4-5	Boiling, general cooking	Cooking larger quantities, soups and stews, steaming potatoes, cooking meat stock or bouillon
3-4	Steaming	Steaming vegetables, braising meats
2-3	Simmering	Simmering rice or milk-based dishes, steaming smaller quantities of potatoes and vegetables, heating ready-to-serve meals
1-2	Melting	Fluffy omelets, keeping dishes warm, melting butter or chocolate

NOTE: These settings are recommended guidelines for cooking. You may need to adjust the power level for the type of food and pan.



GENERAL NOTES ON USING THE APPLIANCE:

- All foods should be covered with a lid or aluminum foil to maintain food quality.
- When warming pastries and bread, the cover should have an opening to allow moisture to escape.
- Do not use plastic wrap to cover foods. Plastic may melt onto the hot surface and be very difficult to clean.
- Use only cookware and dishes recommended as safe for cooktop use.
- Always use potholders when removing foods from the Cooking Zones as cookware and plates will be hot.
- Never warm food for longer than one hour (eggs for 30 minutes), as food quality may deteriorate.
- Do not heat very cold food on a Cooking Zone.
- The quantity and type of food being heated may affect the required heat setting.
- Do not use large pots or large amounts of food as this may cause uneven heating.
- Always heat food to proper food temperatures. USDA recommends food temperatures between 140° and 170°F (except pastries).

USING THE DUAL COOKING ZONE

The Dual Cooking Zone, located in the right rear position, offers two different size elements to accommodate different pan sizes. Use one or two sections of the burner according to the size of the pan.

To Activate the Dual Cooking Zone:

- ① Touch the  pad. The innermost element will activate.
- ② Touch the  pad again to activate the entire element (Dual).
- ③ Select the desired power level.

USING CHILD LOCK

To prevent children from turning the cooktop on accidentally or changing the cooking settings, press the **Child Lock** button. The red light on top of the  button will turn on and the cooktop will not respond to temperature or timer changes. You can press the **Child Lock** button when the cooktop is operating

Setting Child Lock

When you press the **Child Lock** button, the LED display above  will show **Lo**.

When **Child Lock** is on, the only button that will function is the ON/OFF button.

Canceling Child Lock

To turn **Child Lock** off, it is not sufficient to just tap on the **Child Lock** button. You have to press and hold the button for a couple of seconds until you hear a beep and the red light turns off.

TIMER FUNCTION

You are able to link the timer to a cooking zone so after the countdown time is complete, the cooking zone will turn off automatically.

1. Turn on the cooktop by pressing the ON/OFF button
2. Press the cooking zone selection button for the zone that you wish to set the timer for.
3. Touch the **Timer** button and **10** will show in the timer display.
4. Set the required countdown time using the **+** and **-** buttons. The maximum time that can be set is 99 minutes.
5. By pressing the **+** or **-** button once, the time will increase or decrease by 1 minute.
6. If the set time exceeds 99 minutes, the display will automatically return to 00 minutes.
7. Once the required time is set, the countdown will begin immediately. The display will show the remaining time and the indicator will flash for 5 seconds.
8. A red dot next to the power level indicator will illuminate to show the cooking zone that

has the linked timer.

9. All cooking zones can be linked to the timer one by one. You can press another cooking zone once, then press the **Timer** button and then **+** or **-** for the desired timer.
10. If more than one cooking zone has been linked to the **TIMER**, the display will show the time remaining for the zone with the least amount of remaining time.
11. When the countdown time is complete, the corresponding cooking zone will switch off automatically.

IMPORTANT: Any other cooking zones that are in use will remain on.

OTHER FUNCTIONS

Automatic Shutoff

If a Cooking Zone is in constant use for more than 2 hours and the control setting is not changed, the Cooking Zone will shut off automatically.

Automatic Power Level Control

The power level displayed may be different from the actual power level at the high temperature range. To prevent the cooktop from overheating, the power level is controlled automatically.

CARE AND CLEANING

CLEANING THE COOKTOP

Only use an approved ceramic cooktop cleaner on the glass cooktop. Other creams may not be as effective or they might damage the surface with scratches or permanent staining.

To maintain and protect the surface of your glass cooktop, follow these steps:

- ① Before using the cooktop for the first time, clean it with a ceramic cooktop cleaner. This helps protect the top and makes cleanup easier.
- ② Daily use of the ceramic cooktop cleaner will help keep the cooktop looking new.
- ③ Shake the cleaning cream well. Apply a few drops of cleaner directly to the cooktop.
- ④ Use a paper towel to clean the entire cooktop surface.
- ⑤ Rinse with clear water and use a dry cloth or paper towel to remove all cleaning residue.

NOTE: It is very important that you DO NOT heat the cooktop until it has been cleaned thoroughly.



CAUTION

- **DO NOT use scrub pads or abrasive cleaning pads.** They may damage your glass cooktop surface.
- **For your safety, please wear an oven mitt potholder while cleaning the hot cooking surface.**

BURNED-ON RESIDUE

To clean the glass-ceramic

Step 1

First remove any burnt-on deposits or spilled food from your glass-ceramic cooking surface with a suitable metal razor scraper (similar to scraping paint off windowpanes in your home – it will not damage the cooking surface). Hold the scraper at approximately a 30° angle to the cooktop.

NOTE: Do not use a dull or nicked blade. For your safety, wear an oven mitt potholder while using the metal scraper.

Step 2

When the cooking surface has cooled down, apply a few drops (about the size of a dime) of an approved cleaner in each burner area and work the cleaning cream over the cooktop surface with a damp paper towel as if you were cleaning a window.

Step 3

As a final step, clean with clear water and wipe the cooktop surface with a clean, dry paper towel.

Important: If any sugar or food containing sugar (preserves, ketchup, tomato sauce, jellies, fudge, candy, syrups, chocolate, etc.), a plastic item or kitchen foil accidentally melts on the hot surface of your cooktop, remove the molten material **IMMEDIATELY** with a metal razor scraper (it will **not** damage the cooking surface) **while the cooking surface is still hot** to avoid the risk of damage to the glass-ceramic surface. **For your safety please wear an oven mitt potholder while cleaning the hot cooking surface.**

METAL MARKS AND SCRATCHES

- ① Be careful not to slide pots and pans across your cooktop. This will leave metal marks on the cooktop surface. These marks are removable using an approved ceramic cooktop cleaner.
- ② If pots with a thin overlay of aluminum or copper are allowed to boil dry, the overlay may leave a black discoloration on the cooktop. This should be removed immediately before heating again or the discoloration may become permanent.

INSTALLATION INSTRUCTIONS

INSTALLATION AND SERVICE MUST BE PERFORMED BY A QUALIFIED INSTALLER.

IMPORTANT: SAVE THESE INSTRUCTIONS FOR LOCAL ELECTRICAL INSPECTOR'S USE.

READ AND SAVE THESE INSTRUCTIONS FOR FUTURE REFERENCE.

BEFORE YOU BEGIN

Read these instructions completely and carefully.

NOTES TO INSTALLER:

- Read all installation instructions before installing the cooktop.
- Remove all packing material before connecting the electrical supply to the cooktop.
- Observe all governing codes and ordinances.
- Only certain cooktop models may be installed over certain built-in electric oven models.
- Be sure to leave these instructions with the consumer.

NOTE TO CONSUMER:

Keep this *User's Guide and Installation Instructions* manual for future reference.

NOTE: This appliance must be properly grounded.

Damage caused by failure to follow these instructions is not covered by the cooktop warranty.

UNPACKING THE COOKTOP

- ① Unpack and visually inspect the cooktop for any damage or missing components.
- ② It is important that the ceramic-glass cooktop be pretreated before use.
See *CARE AND CLEANING*.

TECHNICAL SPECIFICATIONS

CR4B23T5B & CR4B23T6W Electric Cooktops

Cooktop Dimensions

Width	23.2" (590mm)
Depth	20.5" (520mm)
Height	2" (50 mm)

Cooking Zones

Position	Diameter	Power
Front Left	6.9" (175 mm)	1800 W
Front Right	5.5" (140 mm)	1200 W
Rear Left	5.5" (140 mm)	1200 W
Rear Right	8.1"/5.2" (206/132 mm)	2200 W/1000W

Countertop Cutout Dimensions

Width	22" (558 mm)
Depth	19.5" (498 mm)

Electrical Specifications

Connection voltage: 220-240VAC 60 Hz. 29 A

Maximum connected power load: 6400 W

PREPARING THE INSTALLATION LOCATION

IMPORTANT INSTALLATION INFORMATION

- These electric cooktops run off a single phase, three-wire or four-wire cable, 220-240 volt, 60 hertz, AC-only electrical supply with ground.
- Minimum distance between cooktop and overhead cabinetry is 30" (762 mm).
- Make sure the cabinets and wall coverings around the cooktop can withstand the temperatures (up to 93°C [200°F]) generated by the cooktop.

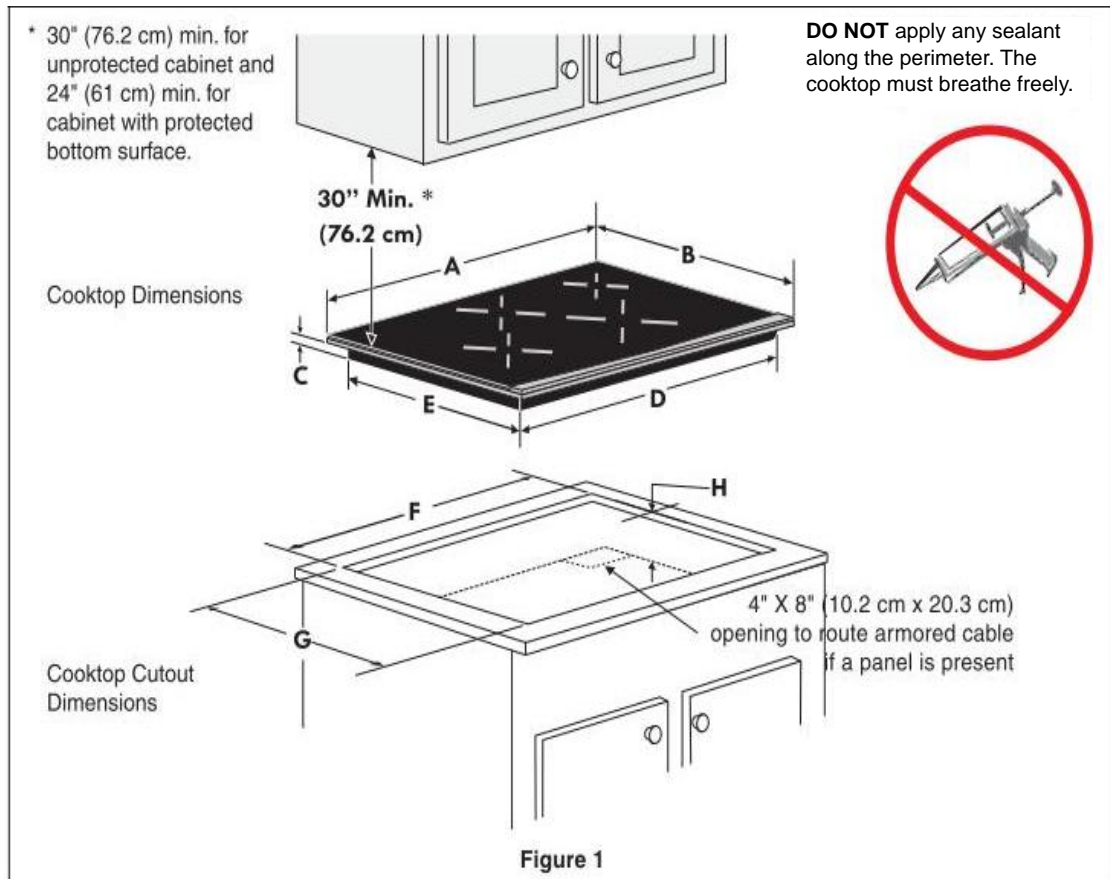

COOKTOP DIMENSIONS					CUTOUT DIMENSIONS		
A.WIDTH	B.DEPTH	C.HEIGHT	D.WIDTH	E.DEPTH	F.WIDTH	G.DEPTH	H.HEIGHT
23.25 (59)	20.5 (52)	2.0 (5)	22(56)	19.25 (49)	22(55.8)	19.5 (49.8)	3.2 (8.1)

NOTE: When preparing the countertop, **radius** the corners of the cutout (1/4" radius is typical). This will prevent cracking of the countertop. Follow manufacturer's instructions regarding minimum corner radius and reinforcement of corners.

DIMENSIONS AND CLEARANCES

COOKTOP INSTALLATION INSTRUCTIONS

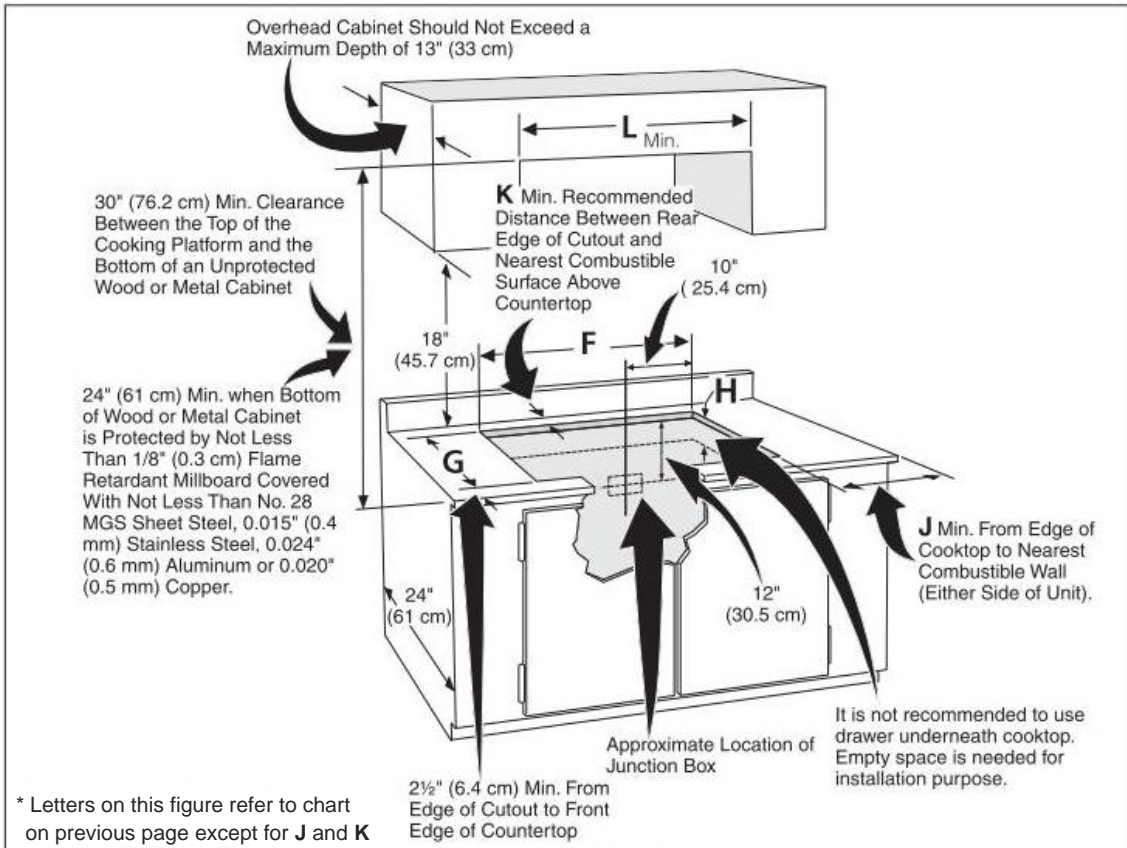

Figure 2 – COUNTERTOP CUTOUT OPENING

CAUTION To eliminate the risk of burns or fire by reaching over heated surfaces, cabinet storage space located above the cooktop should be avoided. If cabinet storage is provided, risk can be reduced by installing a range hood that projects horizontally a minimum of 5" (12.7 cm) beyond the bottom of the cabinets.

Cooktop Width	J	K	L
23"	2"(5.1cm)	1"(2.5cm)	23"(59cm)

Model and Serial Number Location

The serial plate is located under the cooktop. When ordering parts for or making inquiries about your cooktop, always be sure to include the model and serial numbers and a lot number or letter from the serial plate on your cooktop.

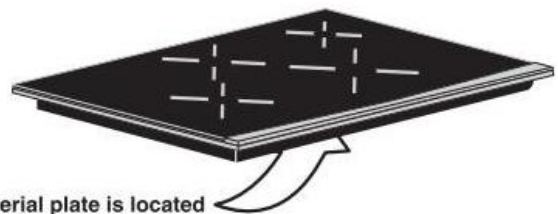

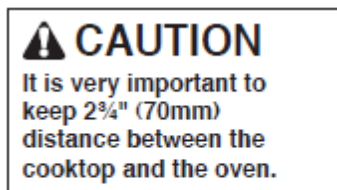

■ **Recommended space between cooktop and oven**

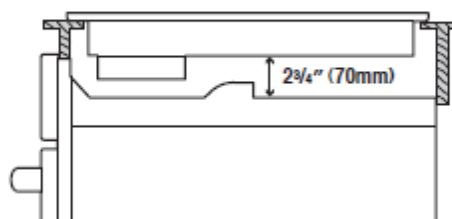

ELECTRICAL CONNECTIONS

IMPORTANT SAFETY INSTRUCTIONS

- Be sure your cooktop is installed and grounded properly by a qualified installer or service technician.
- This cooktop must be electrically grounded in accordance with local codes or, in their absence, with the National Electrical Code ANSI/NFPA No. 70, latest edition in the United States.

PROVIDING THE ELECTRICAL CONNECTION

Install the junction box under the cabinet and run a 220-240 volt AC wire from the main circuit panel.

Note: DO NOT connect the wire to the circuit panel at this time.

⚠ WARNING!

The electrical power to the cooktop must be shut off while line connections are being made. Failure to do so could result in serious injury or death.

ELECTRICAL REQUIREMENTS

Observe all governing codes and local ordinances.

- Follow the guidelines for connecting the cables.
- Before running the cooktop, check the reading on the electric meter and the circuit breaker regulator. Check whether it is properly grounded and appropriately fused.
- The socket should be properly grounded and the circuit should contain a circuit breaker whose splitting distance between 2 wires is at least 3mm (1/8").
- If the product has an accessible output socket:
 - The yellow and green wires inside the cables of the AC source and the connecting cable of the product should be grounded.
 - The manufacturer is not liable to any accident caused by ungrounded or poorly grounded cables.
 - Any issues related to power cables should be directed to the customer service center or to qualified technicians.
 - To avoid any accident, if the power cables are damaged or required to be replaced, the repair work should be carried out with the special equipment operated by dealers.
- The socket should comply with relevant electrical standards, or should contain a 1P circuit breaker with electrical loading of at least 40A.

The installation guide of the cables is shown

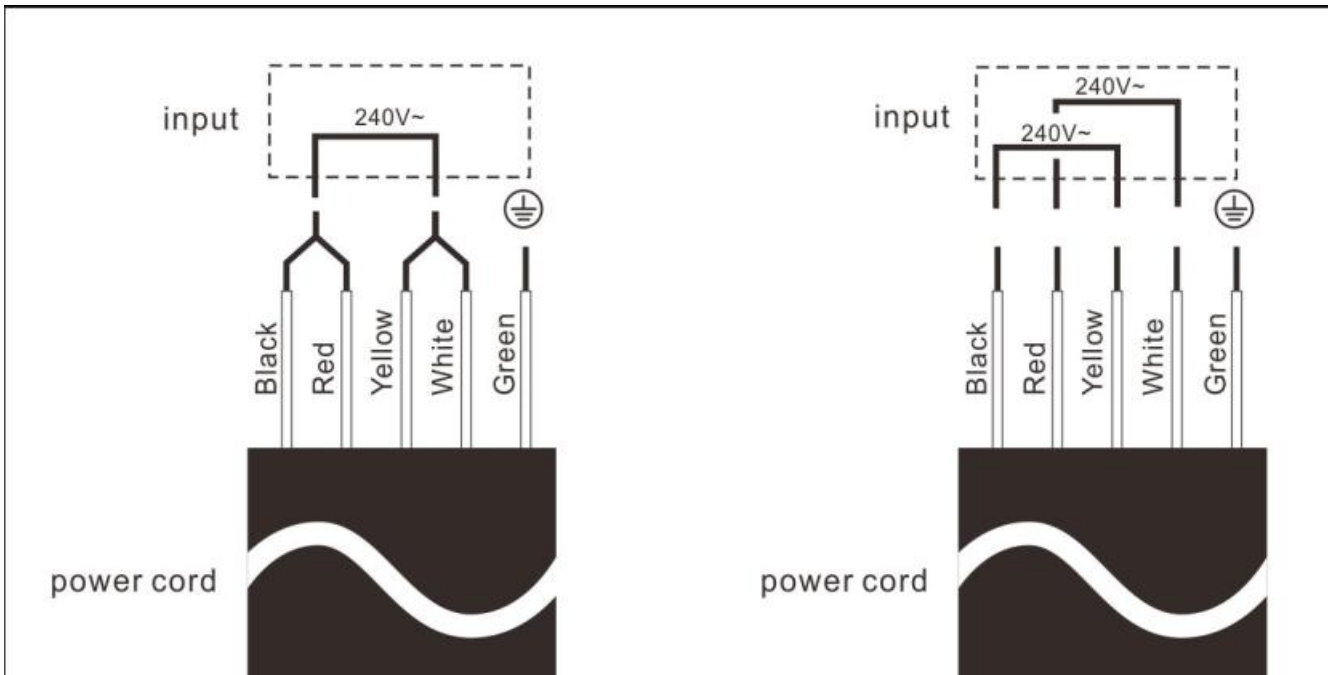

 WARNING!

Electrical grounding is required on this appliance. This appliance is manufactured with a supply wire and a frame-connected grounding wire.

NOTE TO ELECTRICIAN:

The armored cable leads supplied with the appliance are UL-listed for connection to larger gauge household wiring. The insulation of the leads is rated at temperatures much higher than the temperature rating of household wiring. The current-carrying capacity of the conductor wire is governed by the temperature rating of the insulation around the wire, rather than the wire gauge alone.

 WARNING!

DO NOT ground to a gas supply pipe. DO NOT connect to electrical power supply until appliance is permanently grounded. Connect the ground wire before turning on the power.

 WARNING!

This appliance is equipped with a flexible copper conductor cable. If connection is made to aluminum house wiring, use only special connectors which are approved for joining copper and aluminum wires in accordance with the National Electrical Code and local codes and ordinances. Improper connection of aluminum house wiring to copper leads can result in a short circuit or fire. Follow the connector manufacturer's recommended procedure closely.

COOKTOP INSTALLATION

- ① Visually inspect the cooktop for damage. Make sure all cooktop screws are tight (see locations below).

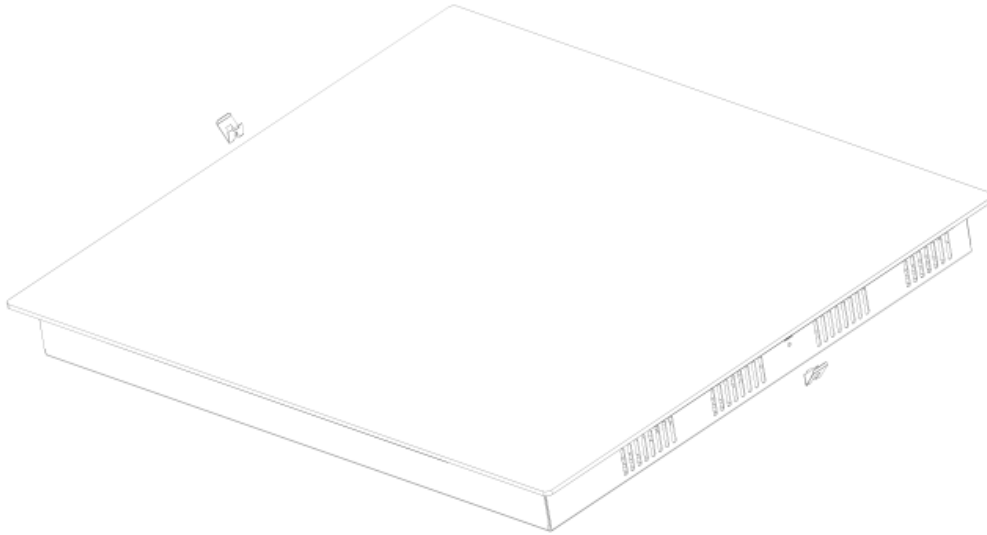

- ② Carefully lower the cooktop into the countertop cutout, making sure not to trap any wires.

NOTE: Do not use caulking compound. The cooktop must be removable, should service be required.

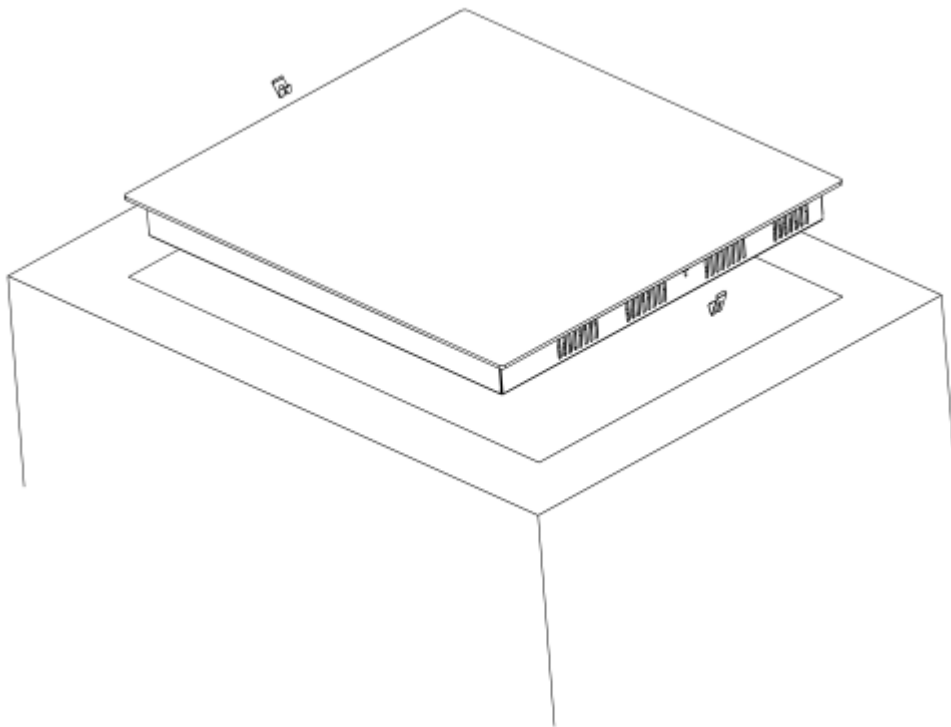

- ③ Install the retainer brackets to the bottom of the cooktop; then snug the bolts against the bottom of the countertop as shown.

NOTE: The retainer brackets **MUST** be installed to meet local codes or, in their absence, with the National Electrical Code ANSI/NFPA No. 70, latest edition.

Preferred installation

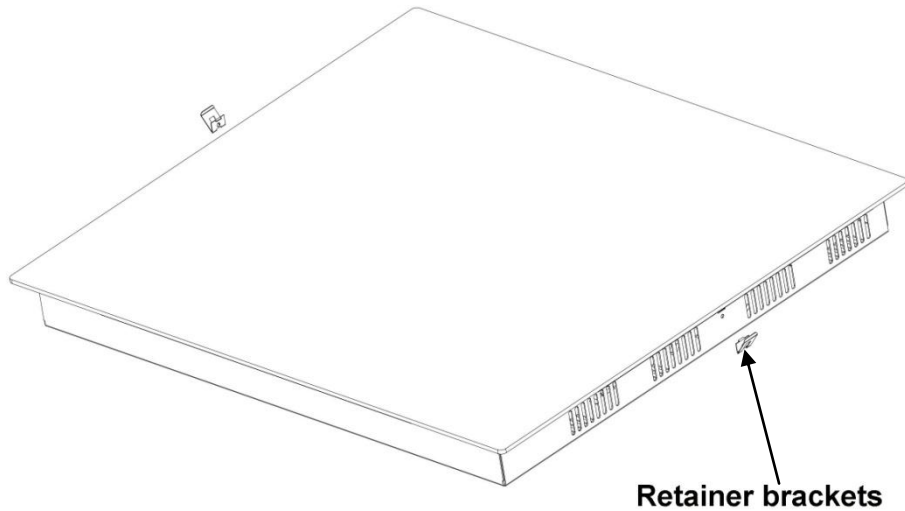

FINAL CHECK

Perform a final operational check of the cooktop, making sure the cooktop powers on properly and that each Cooking Zone operates correctly. Refer to the section *Operating Instructions* in this guide for details.

MODEL AND SERIAL NUMBER LOCATION

The model and serial numbers are located on a plate on the bottom of the cooktop. Please record them in this guide; you will need them for warranty registration.

CAUTION

Do not touch cooktop glass or Cooking Zones. They may be hot enough to cause burns.

TROUBLESHOOTING

BEFORE CALLING FOR SERVICE

Before you call for service, review this list. It may save you time and expense. This list includes common occurrences that are not the result of a defect in workmanship or materials.

Problem	Possible Cause	Solution
Cooktop does not work	<ul style="list-style-type: none"> • Cooktop controls are locked • Circuit breaker has tripped or fuse is blown • Power outage • Installation wiring not complete 	<ul style="list-style-type: none"> • See USING CHILD LOCK to turn off the CHILD LOCK feature • Reset the circuit breaker or replace fuse • Check house lights to confirm power outage • Contact the installer or dealer
Cooktop does not heat	<ul style="list-style-type: none"> • Incorrect Cooking Zone selected • No power to cooktop 	<ul style="list-style-type: none"> • Make sure the correct control is ON for the Cooking Zone being used • See “Cooktop does not work” above
Elements turn off while cooking	<ul style="list-style-type: none"> • Cooktop inner temperature too high 	<ul style="list-style-type: none"> • Check that cooktop has been installed according to the installation instructions
Elements do not get hot enough	<ul style="list-style-type: none"> • Touch controls may not be set properly • Cookware may not be flat or the correct shape or size 	<ul style="list-style-type: none"> • Check the power level • Use the recommended cookware
A fan sound can be heard	<ul style="list-style-type: none"> • Cooktop inner temperature is high 	<ul style="list-style-type: none"> • This is normal. The cooling fan will run when any element is turned on. With heavy use the fan may continue to run after the controls are turned off until the cooktop has cooled.

NOTES

LIMITED WARRANTY

Within the 48 contiguous United States, for one year from the date of purchase, when this appliance is operated and maintained according to instructions attached to or furnished with the product, warrantor will pay for factory-specified parts and repair labor to correct defects in materials or workmanship. Service must be provided by a designated service company. Outside the 48 states, all parts are warranted for one year from manufacturing defects. Plastic parts, shelves and cabinets are warranted to be manufactured to commercially acceptable standards, and are not covered from damage during handling or breakage.

ITEMS WARRANTOR WILL NOT PAY FOR:

- Service calls to correct the installation of your appliance, to instruct you how to use your appliance, to replace or repair fuses or to correct wiring or plumbing.
- Service calls to repair or replace appliance light bulbs or broken glass shelves. Consumable parts (such as filters) are excluded from warranty coverage.
- Damage resulting from accident, alteration, misuse, abuse, fire, flood, acts of God, improper installation, installation not in accordance with electrical or plumbing codes, or use of products not approved by warrantor.
- Replacement parts or repair labor costs for units operated outside the United States.
- Repairs to parts or systems resulting from unauthorized modifications made to the appliance.
- The removal and reinstallation of your appliance if it is installed in an inaccessible location or is not installed in accordance with published installation instructions.

DISCLAIMER OF IMPLIED WARRANTIES – LIMITATION OF REMEDIES

CUSTOMER'S SOLE AND EXCLUSIVE REMEDY UNDER THIS LIMITED WARRANTY SHALL BE PRODUCT REPAIR AS PROVIDED HEREIN. IMPLIED WARRANTIES, INCLUDING WARRANTIES OF MERCHANTABILITY OR FITNESS FOR A PARTICULAR PURPOSE, ARE LIMITED TO ONE YEAR. WARRANTOR SHALL NOT BE LIABLE FOR INCIDENTAL OR CONSEQUENTIAL DAMAGES. SOME STATES DO NOT ALLOW THE EXCLUSION OR LIMITATION OF INCIDENTAL OR CONSEQUENTIAL DAMAGES, OR LIMITATIONS ON THE DURATION OF IMPLIED WARRANTIES OF MERCHANTABILITY OR FITNESS, SO THESE EXCLUSIONS OR LIMITATIONS MAY NOT APPLY TO YOU. THIS WARRANTY GIVES YOU SPECIFIC LEGAL RIGHTS AND YOU MAY ALSO HAVE OTHER RIGHTS, WHICH VARY FROM STATE TO STATE.

***Call SUMMIT customer service toll-free in the U.S.A. @ 1-800-932-4267,
Monday to Friday 9:00 AM - 5:00 PM (ET).***

Order parts online at www.summitappliance.com/support

WARNING! This product may contain chemicals known to the state of California to cause cancer or birth defects or other reproductive harm. For more information, visit: www.summitappliance.com/prop65

Chemicals known by the manufacturer to be present in this product in concentrations higher than threshold limits: NONE.

SUMMIT

Felix Storch, Inc.
Summit Appliance Division
770 Garrison Avenue
Bronx, NY 10474

Phone: (718) 893-3900
Fax: (844) 478-8799
www.summitappliance.com

Printed in China
Revised March 2017