



2-Burner Electric Cooktops

Models:

CR2B23T3B

CR2B23T4W

CR2B23T3BTK15

CR2B23T4WTK15

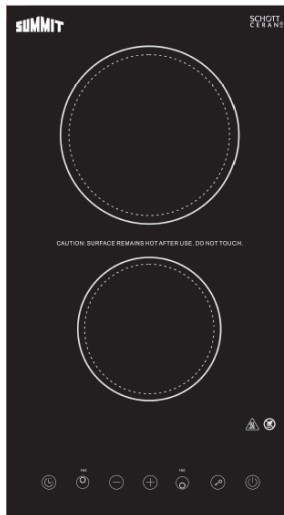

CR2B15T1B

CR2B15T2W

CR2B15T1BTK15

CR2B15T2WTK15

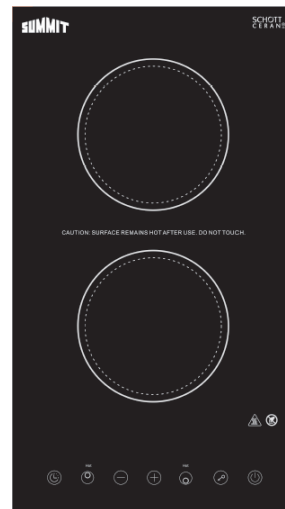

USER'S MANUAL

- ◆ Please read this manual carefully before use and keep it in a safe place for future reference.
- ◆ Some figures in this manual are for reference only and may not exactly match the product you purchased.
- ◆ Model numbers with **TK15** in the suffix include a Trim Kit that allows the unit to fit into a 15" wide cutout.

FELIX STORCH, INC.

An ISO 9001:2015 registered company

770 Garrison Avenue

Bronx, New York 10474

www.summitappliance.com

TABLE OF CONTENTS

Important Safeguards	3 – 5
<i>Electrical safety</i>	3
<i>Safety during use</i>	3 – 4
<i>Safety when cleaning</i>	4
<i>How to avoid damaging the appliance</i>	4
<i>Pots and pans</i>	5
Installation	6 – 8
<i>Appliance and cut-out dimensions</i>	6
<i>Electrical connections</i>	7 – 8
Cooking Zones and Controls	9 - 11
Operating Instructions	11 – 12
<i>Before using for the first time</i>	11
<i>Operating the cooktop</i>	11– 12
Care and Cleaning	13 – 14
<i>Cleaning the cooktop</i>	13
<i>Burned-on residue</i>	13
<i>Metal marks and scratches</i>	14
Technical Data	14
Troubleshooting	15
Limited Warranty	16



IMPORTANT SAFEGUARDS



WARNING: INSTALLATIONS MUST COMPLY WITH ALL LOCAL, STATE AND NATIONAL ELECTRICAL CODES. This appliance must be properly installed and grounded by a qualified technician.

Failure to comply with the applicable codes may result in fire, property damage, personal injury or death.

If the electric power supply does not meet the product specifications, consult with a licensed electrician before proceeding with installation.

Save this documentation for review by local inspector.

Electrical safety

Please follow these instructions; otherwise the warranty will not cover any damage that may occur.

1. The installation and connection of the new appliance must only be carried out by qualified personnel.
2. Repairs to the appliance are only to be carried out by approved service persons. Repairs carried out by inexperienced persons may cause injury or serious malfunctioning. If your appliance needs repairing, please contact your local Service Center.
3. The electrical connection may be made by incorporating a switch in the fixed wiring in accordance with wiring regulations.
4. Flush-mounted appliances may only be operated following installation in suitable cabinets and workplaces which conform to the relevant standards. This ensures sufficient protection against electric shock as required by a certification body.
5. If your appliance malfunctions or fractures:
 - Switch off all cooking zones, and contact the Service Center.
 - If the surface is cracked, switch off the appliance to avoid the possibility of electric shock. Do not re-use your cooktop until the glass surface has been replaced.
 - If the supply cord is damaged, it must be replaced by a service agent or similarly qualified person in order to avoid a hazard.

Safety during use

1. This appliance may only be used for normal cooking and frying in the kitchen.
2. Do not use the appliance to heat the room.
3. Take care when plugging in electric appliances near the cooktop. Connection leads must not come into contact with the hot surface.
4. Overheated fats and oils catch fire quickly. Be especially careful when cooking foods in fat or oil.
5. Switch off the cooking zones after use.
6. Always keep the control panel clean and dry.

7. Never place combustible items on the cooktop.
8. You must not keep any combustible items such as aerosol cans in a drawer located under the cooktop. Likewise, do not keep items made of plastic with a low melting point in a drawer below the cooktop.
9. To eliminate the risk of burns from reaching over heated surface units, cabinet storage space located above surface units should be avoided. If cabinet storage is necessary, the risk can be reduced by installing a range hood that projects horizontally a minimum of 5" beyond the bottom of the cabinets.
10. The service cables from electrical appliances must not touch the hot plates. This could cause damage to the cooktop and cable insulation.
11. This appliance is not intended for use by young children or infirm persons unless they are adequately supervised by a responsible person to ensure that they are using the appliance safely.
Young children should be supervised to ensure that they do not play with the appliance.
12. Accessible parts become hot during use. Young children should be kept away.
13. The cooking zones will become hot when you cook. Therefore, always keep small children away from the appliance. Although the cooktop is equipped with a control lock, surfaces may still be hot.

Safety when cleaning

1. Always switch off the appliance before cleaning.
2. For safety reasons, do not clean the appliance with a steam jet or high pressure cleaner.
3. Clean the cooktop in accordance with the *Care and Cleaning* instructions in this manual.
4. Do not use harsh cleansers or abrasive cleaning pads to clean the ceramic glass surface since they can scratch the surface, which may result in shattering of the glass.

How to avoid damaging the appliance

1. Do not use the cooking area as a worktop or storage space.
2. Please be careful of the edges when moving pots and pans around.
3. Do not leave the cooking zones on with empty pans, or with no pots or pans on them.
4. Ceramic glass is very tough and impervious to sharp temperature changes, but is not unbreakable. It can be damaged if particularly hard or sharp objects fall on it.
5. Be very cautious if using pots made of cast iron, or other pots with rough edges or burrs. Moving these can cause scratches on glass.
6. If sugar or a mixture containing sugar falls onto a hot cooking zone and melts, remove immediately, while still hot. If left to cool down, it may damage the surface when removed.
7. Keep objects or materials liable to melt away from the ceramic glass surface, for example, plastic utensils, aluminum foil, or cooking wraps. If any other materials or foodstuffs have melted on the ceramic glass surface, these should also be cleaned away immediately.

Pots and pans

The better the pot, the better the cooking results.

1. You can recognize good pots and pans by their bases. The base should be as thick and flat as possible.



2. When buying new pots and pans, pay particular attention to the diameter of the base. Manufacturers often only state the diameter of the rim.
3. Pots with aluminum or copper bases can cause metallic discoloration on the ceramic glass surface which is very difficult or impossible to remove.
4. Be very careful when using cast iron pots or pots with damaged bases that are rough and/or have burrs on them. Scratches can occur if they are slid across the surface.
5. When cold, pot bases are normally bowed slightly inwards (concave). They should never be bowed outwards (convex).
6. If you use special pots and pans (e.g., a pressure cooker, simmering pan, wok, etc.), please observe the manufacturer's instructions.
7. For safety reasons, do not clean the appliance with a steam jet or high pressure cleaner.

INSTALLATION



Important! This new appliance may only be installed and connected by a registered specialist. Please observe these instructions; otherwise the warranty will not cover any damage that may occur.

- **Appliance dimensions**

Width	290mm (11.42")
Depth	520mm (20.5")
Height	50mm (2.0")

- **Countertop cut-out dimensions**

Width	273mm (10.75")
Depth	505mm (19.9")
Height	150mm (5.9")

NOTE: If your cutout is closer to 15" than 10.75" wide, you should be using one of our **TK15** model cooktops.

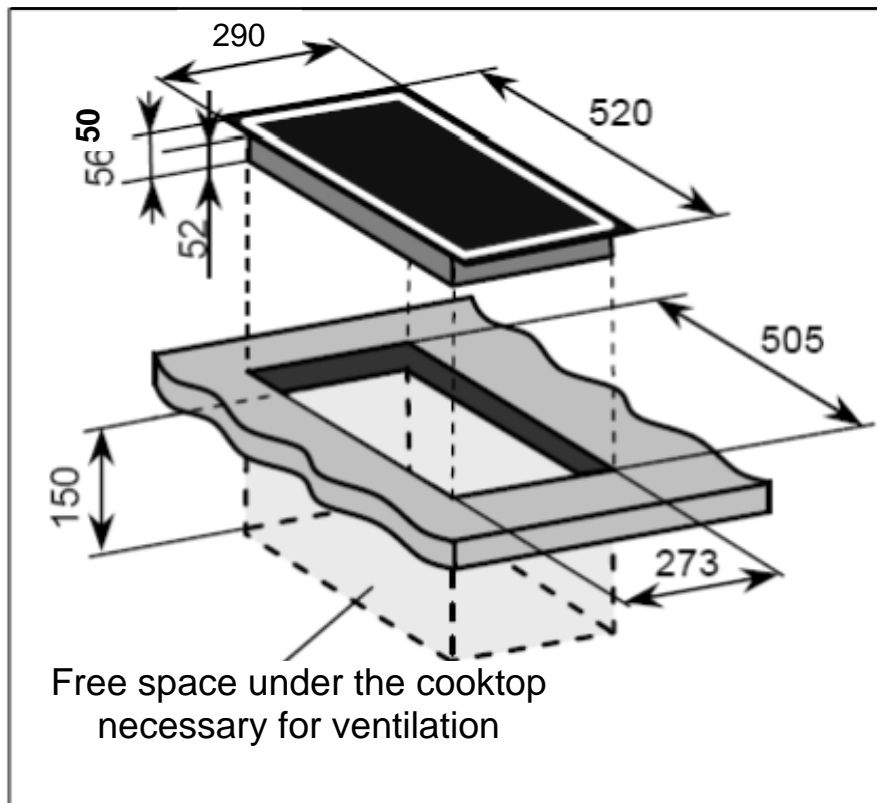

NOTE: When preparing the countertop, **radius** the corners of the cutout (1/4" radius is typical). This will prevent cracking of the countertop. Follow manufacturer's instructions regarding minimum corner radius and reinforcement of corners.

NOTE: To install TK15 models: For wider cutouts, use the stainless steel frame supplied with your **TK15** cooktop. Lay a thin bead of bedding compound along the edge of the cutout, and then lay the frame over this, pressing down to make a good seal once the frame is centered. The frame should be as flush with the countertop as possible.

ELECTRICAL CONNECTIONS

IMPORTANT SAFETY INSTRUCTIONS

- Be sure your cooktop is installed and grounded properly by a qualified installer or service technician.
- This cooktop must be electrically grounded in accordance with local codes or, in their absence, with the National Electrical Code ANSI/NFPA No. 70, latest edition in the United States.

PROVIDING THE ELECTRICAL CONNECTION

Install the junction box under the cabinet and run either a 120 volt AC wire (for models CR2B15T1B and CR2B15T2W) or a 220-240 volt AC wire (for models CR2B23T3B and CR2B23T4W) from the main circuit panel.

Note: DO NOT connect the wire to the circuit panel at this time.

⚠ WARNING!

The electrical power to the cooktop must be shut off while line connections are being made. Failure to do so could result in serious injury or death.

ELECTRICAL REQUIREMENTS

Observe all governing codes and local ordinances.

- Follow the guidelines for connecting the cables
- Before running the cooktop, check the reading on the electric meter and the circuit breaker regulator. Check whether it is properly grounded and appropriately fused.
- The socket should be properly grounded and the circuit should contain a circuit breaker whose splitting distance between 2 wires is at least 3mm ($\frac{1}{8}$ ").
- If the product has an accessible output socket:
 - The yellow and green wires inside the cables of the AC source and the connecting cable of the product should be grounded.
 - The manufacturer is not liable to any accident caused by ungrounded or poorly grounded cables.
 - Any issues related to power cables should be directed to the customer service center or a qualified technician.
 - To avoid any accident, if the power cables are damaged or required to be replaced, the repair work should be carried out using the special equipment operated by dealers.
- The socket should comply with relevant electrical standards, or should contain a 1P circuit breaker with electrical loading of at least 40A.

The installation guide for the cables is shown on the following page.

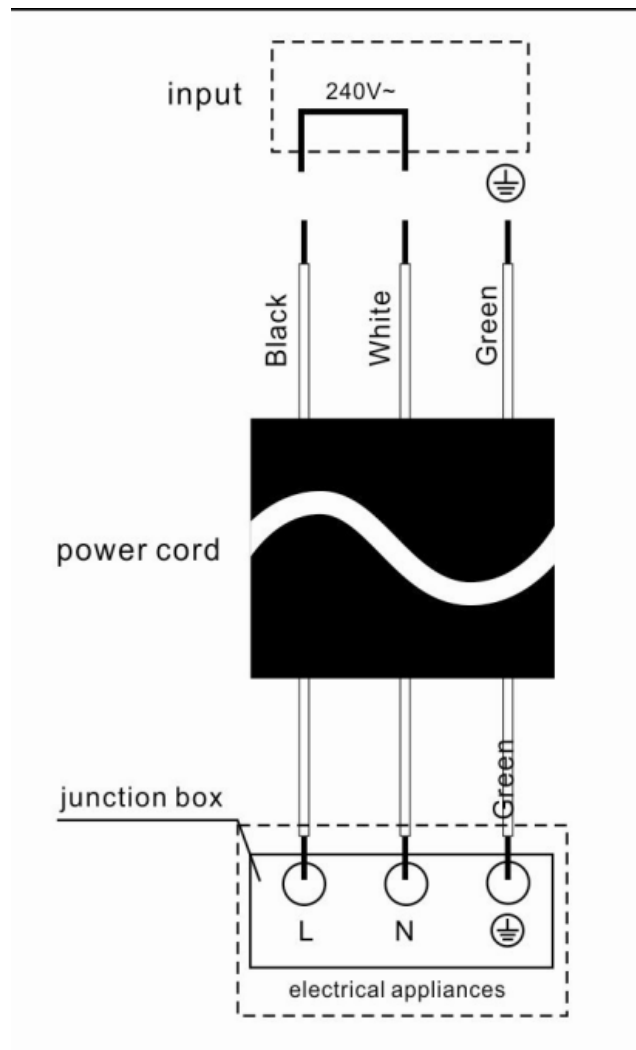

WARNING!

Electrical grounding is required on this appliance. This appliance is manufactured with a supply wire and a frame-connected grounding wire.

NOTE TO ELECTRICIAN:

The armored cable leads supplied with the appliance are UL-listed for connection to larger gauge household wiring. The insulation of the leads is rated at temperatures much higher than the temperature rating of household wiring. The current-carrying capacity of the conductor wire is governed by the temperature rating of the insulation around the wire, rather than the wire gauge alone.



WARNING!

DO NOT ground to a gas supply pipe. DO NOT connect to electrical power supply until appliance is permanently grounded. Connect the ground wire before turning on the power.



WARNING!

This appliance is equipped with a flexible copper conductor cable. If connection is made to aluminum house wiring, use only special connectors which are approved for joining copper and aluminum wires in accordance with the National Electrical Code and local codes and ordinances. Improper connection of aluminum house wiring to copper leads can result in a short circuit or fire. Follow the connector manufacturer's recommended procedure closely.

COOKING ZONES AND CONTROLS

Models CR2B23T3B/TK15 & CR2B23T4W/TK15

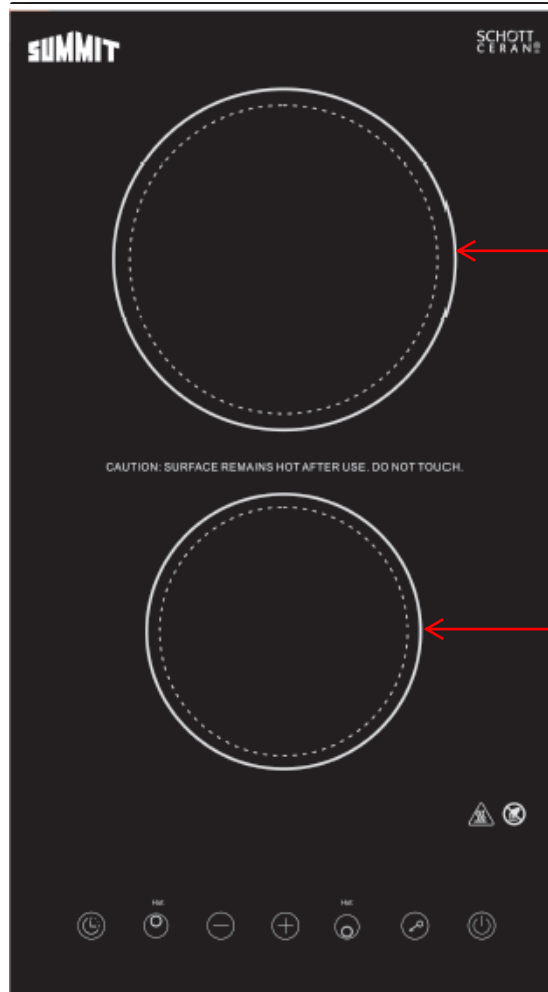

Single cooking zone
6.9" (175mm)
1800W/230V

Single cooking zone
5.5" (140mm)
1200W/230V

Residual heat indicators

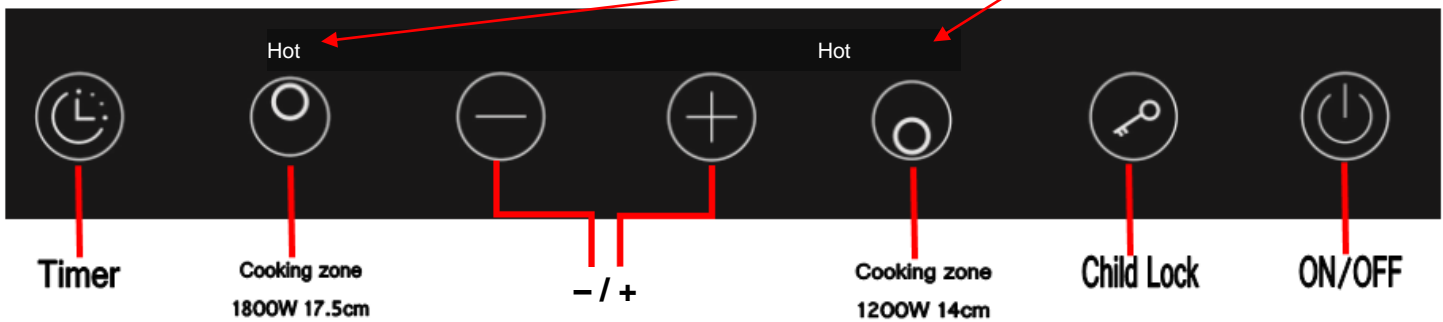

Models CR2B15T1B/TK15 & CR2B15T2W/TK15

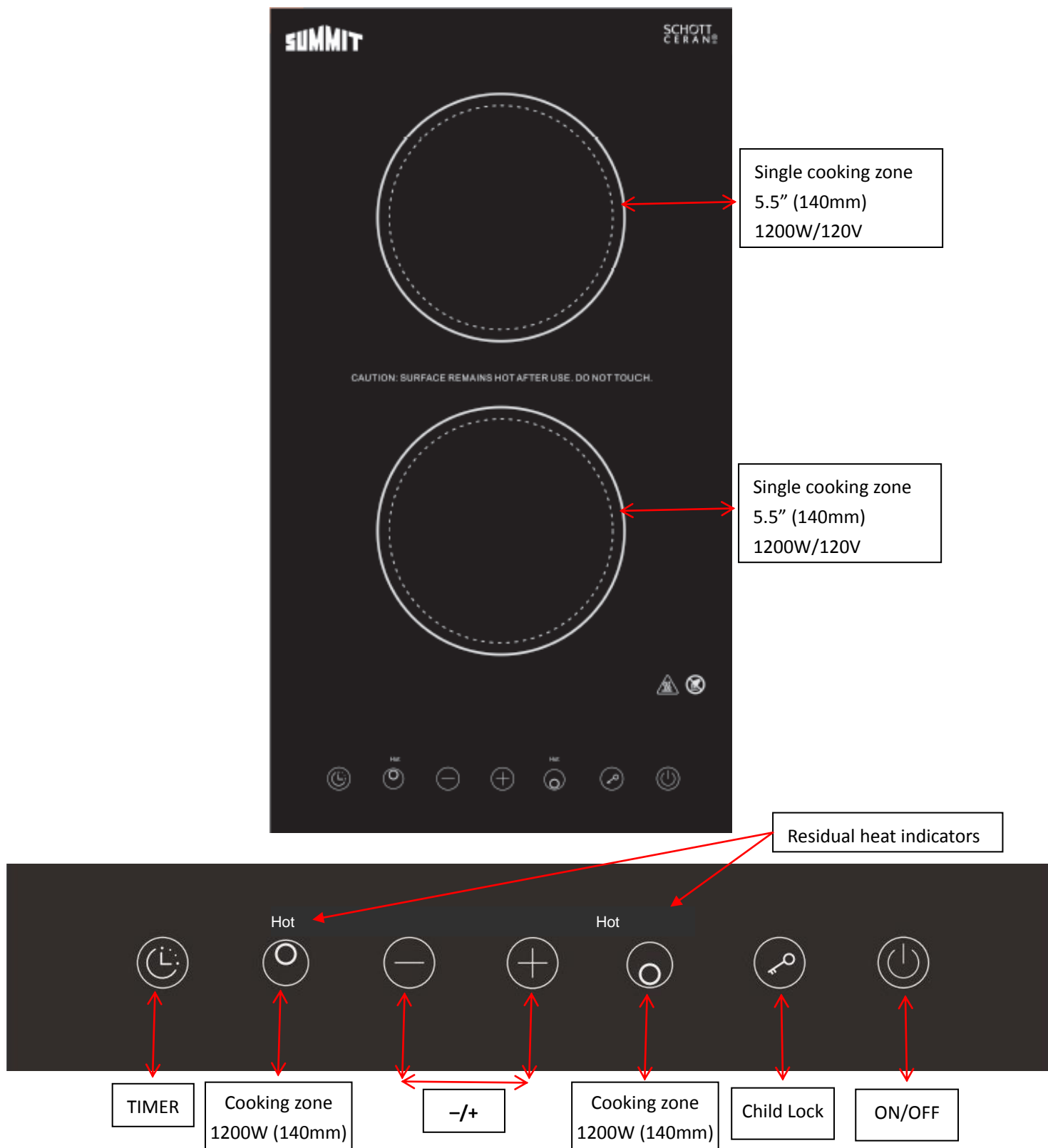

- **Cooking zones:** The appliance is fitted with ceramic glass.
- **Touch Control:** Your appliance is operated using Touch Control.
- **Easy cleaning:** The advantage of the ceramic glass cooking surface and touch control is their accessibility for cleaning. The flat surface is easy to clean.

- **Control and function indicators:** Digital indicators provide information about settings made, functions activated, as well as any residual heat of the corresponding cooking zone.
- **Safety cut-off:** A safety cut-off ensures that all cooking zones switch off if the ON/OFF key is pressed, but no power levels are selected within 1 minute.
- **ON/OFF:** Switches power on and off with one touch.
- **Residual heat indicator:** Shows burner is still hot even though turned off.
- **Child Lock:** With this key the control can be locked as a safety precaution for children.
- **Timer:** When the end of the cooking time has been reached, the cooking zone switches off.
- **-/+:** Adjust the Timer setting with these keys.

OPERATING INSTRUCTIONS

Before using for the first time

- **Initial cleaning**

Wipe the ceramic glass surface with a damp cloth and ceramic cooktop glass cleaner.

Important: Do not use any caustic, abrasive cleansers! The surface could be damaged.

Tip: Once the ON/OFF key has been pressed to switch on the appliance, one of the cooking zones must be selected within approximately 1 minute using the cooking zone selection keys. Otherwise the appliance switches off again for safety.

Operating the cooktop

- **Touch Control Keys**

To operate a Touch Key, simply place your finger firmly on the key.

- **Switching on the Appliance**

The entire appliance is switched on using the ON/OFF key.

Touch the ON/OFF key for approx. one second.

The digital display will show [-] [-].

The indicator above ON/OFF will light up.

- **Cooking zone selection**

For setting and adjusting the power level (0 to 9) for cooking, touch the key of the appropriate cooking zone.

● Heat Level Setting

To select the appropriate cooking zone and set the heat level, touch the corresponding cooking zone key.

Touch the cooking zone key once, and the default digital display shows [5].

Keep touching the key of the desired cooking zone, and the heating level will loop through the settings from [0] to [9].

Tips: When you touch back to zero, the burners do not turn off, but remain in a stand-by mode.

For a faster adjustment, touch and hold the cooking zone key until the desired value is reached.

● Residual Heat Indicators

Your cooktop has a residual heat indicator, marked **Hot**, over each of the two Cooking Zone keys. The indicator warns that this area has been used and is still giving off enough heat to cause burns. *Avoid touching the Cooking Zone when this indicator is lit.* Although the cooktop is OFF, the light will stay lit until the cooktop has cooled down.

● Child Lock

With this key the controls can be locked as a safety precaution for children.

Press once and all buttons are locked except the ON/OFF button. When you touch this key once more for 3 sec., Child Lock will be released. Or you can press ON/OFF to cancel this setting.

● Timer

Duration of cooking can be set with the integrated timer for all cooking zones. When the end of the cooking duration is reached, the cooking zone switches off automatically.

1. Using the cooking zone keys, select the required cooking zone and set the required heat level.
2. Touch the TIMER key to activate the timer function for this cooking zone.
[00] will appear in the display.
3. The indicator light of the TIMER key will turn on.
4. Using the -/+ keys, set or adjust the required period of time (e.g., 30 minutes). The range of the timer is 00 to 99 minutes.
5. After a few seconds the timer will start automatically and will show how much time remains before it will switch off.
6. At the end of the set cooking time, the cooking zone will switch off automatically and a signal will sound.

Tips: To set the timer more quickly, leave your finger on the -/+ key until the required time is reached.

Once the TIMER key has been pressed to switch into TIMER mode, the + key must be pressed to select the timer within approx. 5 seconds. Otherwise TIMER mode will be cancelled.

To cancel TIMER mode, adjust timer to [00].

CARE AND CLEANING

Cleaning the cooktop

Only use an approved ceramic cooktop cleaner on the glass cooktop. Other creams may not be as effective or they might damage the surface with scratches or permanent staining.

To maintain and protect the surface of your glass cooktop, follow these steps:

- ① Before using the cooktop for the first time, clean it with a ceramic cooktop cleaner. This helps protect the top and makes cleanup easier.
- ② Daily use of the ceramic cooktop cleaner will help keep the cooktop looking new.
- ③ Shake the cleaning cream well. Apply a few drops of cleaner directly to the cooktop.
- ④ Use a paper towel to clean the entire cooktop surface.
- ⑤ Rinse with clear water and use a dry cloth or paper towel to remove all cleaning residue.

NOTE: It is very important that you DO NOT heat the cooktop until it has been cleaned thoroughly.



CAUTION

- **DO NOT use scrub pads or abrasive cleaning pads.** They may damage your glass cooktop surface.
- **For your safety, please wear an oven mitt potholder while cleaning the hot cooking surface.**

Burned-on residue

To clean the glass-ceramic

Step 1

First remove any burnt-on deposits or spilled food from your glass-ceramic cooking surface with a suitable metal razor scraper (similar to scraping paint off windowpanes in your home – it will not damage the cooking surface). Hold the scraper at approximately a 30° angle to the cooktop.

NOTE: Do not use a dull or nicked blade. For your safety, wear an oven mitt potholder while using the metal scraper.

Step 2

When the cooking surface has cooled down, apply a few drops (about the size of a dime) of an approved cleaner in each burner area and work the cleaning cream over the cooktop surface with a damp paper towel as if you were cleaning a window.

Step 3

As a final step, clean with clear water and wipe the cooktop surface with a clean, dry paper towel.

Important: If any sugar or food containing sugar (preserves, ketchup, tomato sauce, jellies, fudge, candy, syrups, chocolate, etc.), a plastic item or kitchen foil accidentally melts on the hot surface of your cooktop, remove the molten material **IMMEDIATELY** with a metal razor scraper (it will **not** damage the cooking surface) **while the cooking surface is still hot** to avoid the risk of damage to the glass-ceramic surface. **For your safety please wear an oven mitt potholder while cleaning the hot cooking surface.**

Metal marks and scratches

- ① Be careful not to slide pots and pans across your cooktop. This will leave metal marks on the cooktop surface. These marks are removable using an approved ceramic cooktop cleaner.
- ② If pots with a thin overlay of aluminum or copper are allowed to boil dry, the overlay may leave a black discoloration on the cooktop. This should be removed immediately before heating again or the discoloration may become permanent.

TECHNICAL DATA

● **Appliance dimensions**

Width	290mm (11.42")
Depth	520mm (20.5")
Height	50mm (2.0")

● **Worktop cut-out dimensions**

Width	273mm (10.75")
Depth	505mm (19.9")
Height	150mm (5.9")

● **Cooking elements (Models CR2B23T3B & CR2B23T4W, also TK15 versions)**

Position	Diameter	Power
Upper	175mm (6.9")	1800W
Lower	140mm (5.5")	1200W

Connection voltage 220-240VAC~ 60Hz

Maximum connected load power 3.0KW

● **Cooking elements (Models CR2B15T1B & CR2B15T2W, also TK15 versions)**

Position	Diameter	Power
Upper	140mm (5.5")	1200W
Lower	140mm (5.5")	1200W

Connection voltage 120VAC ~ 60Hz

Maximum connected load power 2.4KW

NOTE: **TK15** in the model number suffix indicates that the model includes a Trim Kit that allows the unit to fit into a 15" wide cutout.

TROUBLESHOOTING

Problem Description	Reason
Burner not glowing red after selecting cooking zone (approximately 3 seconds)	<ul style="list-style-type: none"> * Plug not inserted into an active socket * Break in inner circuit
Burner glowing red intermittently	* The cooktop temperature is controlled by switching the heat on and off. This means that it is not always possible to see the burner glowing red. If you select a low heat setting, the heat will switch off more often than at higher heat settings. The heat also switches on and off at the highest setting.
Heating plate broken	* Stop using the cooktop if there is a crack, chip or missing piece.
Heating time longer than expected	<ul style="list-style-type: none"> * Concavity of pot base is too great. * Size of pot base is too big.



This symbol on the product or in the instructions means that your electrical and electronic equipment should be disposed of at the end of its useful life separately from your household waste. For more information please contact your local authorities or the retailer where you purchased the product.

LIMITED WARRANTY

Within the 48 contiguous United States, for one year from the date of purchase, when this appliance is operated and maintained according to instructions attached to or furnished with the product, warrantor will pay for factory-specified parts and repair labor to correct defects in materials or workmanship. Service must be provided by a designated service company. Outside the 48 states, all parts are warranted for one year from manufacturing defects. Plastic parts, shelves and cabinets are warranted to be manufactured to commercially acceptable standards, and are not covered from damage during handling or breakage.

ITEMS WARRANTOR WILL NOT PAY FOR:

- Service calls to correct the installation of your appliance, to instruct you how to use your appliance, to replace or repair fuses or to correct wiring or plumbing.
- Service calls to repair or replace appliance light bulbs or broken glass shelves. Consumable parts (such as filters) are excluded from warranty coverage.
- Damage resulting from accident, alteration, misuse, abuse, fire, flood, acts of God, improper installation, installation not in accordance with electrical or plumbing codes, or use of products not approved by warrantor.
- Replacement parts or repair labor costs for units operated outside the United States.
- Repairs to parts or systems resulting from unauthorized modifications made to the appliance.
- The removal and reinstallation of your appliance if it is installed in an inaccessible location or is not installed in accordance with published installation instructions.

DISCLAIMER OF IMPLIED WARRANTIES – LIMITATION OF REMEDIES

CUSTOMER'S SOLE AND EXCLUSIVE REMEDY UNDER THIS LIMITED WARRANTY SHALL BE PRODUCT REPAIR AS PROVIDED HEREIN. IMPLIED WARRANTIES, INCLUDING WARRANTIES OF MERCHANTABILITY OR FITNESS FOR A PARTICULAR PURPOSE, ARE LIMITED TO ONE YEAR. WARRANTOR SHALL NOT BE LIABLE FOR INCIDENTAL OR CONSEQUENTIAL DAMAGES. SOME STATES DO NOT ALLOW THE EXCLUSION OR LIMITATION OF INCIDENTAL OR CONSEQUENTIAL DAMAGES, OR LIMITATIONS ON THE DURATION OF IMPLIED WARRANTIES OF MERCHANTABILITY OR FITNESS, SO THESE EXCLUSIONS OR LIMITATIONS MAY NOT APPLY TO YOU. THIS WARRANTY GIVES YOU SPECIFIC LEGAL RIGHTS AND YOU MAY ALSO HAVE OTHER RIGHTS, WHICH VARY FROM STATE TO STATE.

Call SUMMIT customer service toll-free in the U.S.A. @ 1-800-932-4267, Monday to Friday 9:00 AM - 5:00 PM (ET).

Order parts online at www.summitappliance.com/support



WARNING: This product can expose you to chemicals including Nickel (Metallic) which is known to the State of California to cause cancer.

For more information go to www.P65Warnings.ca.gov

Note: Nickel is a component in all stainless steel and some other metal components.

SUMMIT

Felix Storch, Inc.
Summit Appliance Division
770 Garrison Avenue
Bronx, NY 10474

Phone: (718) 893-3900
Fax: (844) 478-8799
www.summitappliance.com